



OE8206 - Lincat Opus 800 Electric Counter-top Griddle - W 900 mm - 12.0 kW

Cooking a Full English Breakfast has never been easier than it is with the Opus 800 Electric Griddle, which utilises a maximised cooking area.

- ✔ Maximised cooking area, griddle plates sit flush to the sides of the unit
- ✔ Two separately controlled heat zones give you the option of operating either zone independently to provide a smaller cooking area during quiet periods as well as offering versatility when cooking two separate meals simultaneously

Specifications

Summary

Brand	Lincat
Range	Opus 800
Power Type	Electric
Unit Type	Counter-top
Available in UK Only	No
UK Warranty	2 Years Parts and Labour Warranty
Export Warranty	Contact your local dealer
GTIN	5056105102533

Power and Performance

Total Power kW	12.0
Temperature Range °C	90-300
IP Rating	IP24
Cooking Area (Width x Depth) mm	890 x 600
Temperature Control	Mechanical

Key Specifications

Number of Heat Zones	2
Grill Plate Surface Type	Smooth
Grill Plate Material	Steel

Capacity

Product Output per Hour	160 x 225g [8oz] steaks [chilled]
--------------------------------	-----------------------------------

Weights and Dimensions

Unit Height (External) mm	428
Unit Width (External) mm	900
Unit Depth (External) mm	800
Net Weight Kg	111

Supply Connections

Requires Installation	Yes
Requires Electrical Supply	Yes
UK 3 Pin Plug	No
Requires Hardwiring	Yes
Electrical Supply Rating Watts	12,000
Single Phase Amps	52.2
Single Phase Voltage	230
Three Phase Amps	L1=17.4; L2=17.4; L3=17.4
Three Phase Voltage	400

Shipping

Packed Weight Kg	122.1
Packed Height cm	64
Packed Width cm	100
Packed Depth cm	85

Available Accessories

LK11	OPUS 800 LONG LEG KIT
OA8914	Lincat Opus 800 Free-standing Floor Stand with Legs - for units W 900 mm
OA8914/C	Lincat Opus 800 Free-standing Floor Stand with Castors - for units W 900 mm
OA8973	Lincat Opus 800 Free-standing Pedestal with Doors and Legs - for units W 900 mm

Available Accessories

OA8973/C

Lincat Opus 800 Free-standing Pedestal with Doors and Castors - for units W 900 mm

Technical Picture

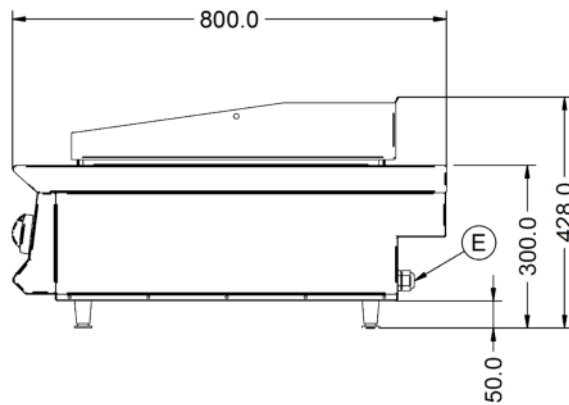
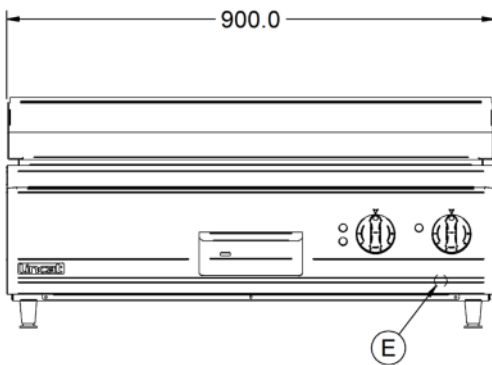
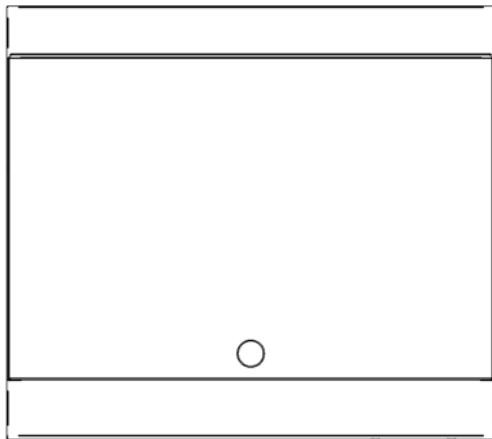



Lincat Limited

Whisby Road,
Lincoln, LN6 3QZ,
United Kingdom

Company No: 2175448

A member company of



Customer Care

Tel: +44 1522 875500
Email: care@lincat.co.uk

Export Customers

Tel: +44 1522 875536
Email: export@lincat.co.uk

Opening Hours

Monday – Friday:
8.30am – 5pm