

Model

NSV300

Product Description

Slicer, 300mm, Vertical, Medium Duty

Product Code

5S518N



Standard Features

- High quality, vertical slicer
- Designed for light to medium duty usage. Ideally suited to smaller shops, delis, cafés, restaurants and small school kitchens
- Large product support surface and high side walls are ideal for slicing fresh meat and ham
- Ideal for precision slicing and delicate meats
- Hollow ground chromed carbon steel blade
- Powerful twin poly 'V' belt driven transmission gives a smooth cutting action and silent running
- Easy set thickness control allows for precision slicing
- Built-in sharpening unit
- Carriage slides on ball bearings for smooth carriage glide
- Anodised aluminium body is hygienic and durable
- Entirely detachable for easy cleaning
- Optional voltages and frequencies available on request
- CE Approved

Standard Accessories

- 1 x Knife Remover
- 1 x Flat Head Screwdriver
- 1 x Tasteless Oil

Warranty

Covered by Metcalfe 2-year warranty (1st year parts and labour, 2nd year parts only) and full after sales service

Optional Accessories

Item
Stainless Steel Knife Remover
Aluminium Knobs
Plastic Cover – Small

Item
Stainless Steel Guard
Special Arm (Protected)
Serrated Blade

Item
Painting Customisation
Teflon Coated Parts (Blade Cover, Gauge Plate, Blade)

Drawing

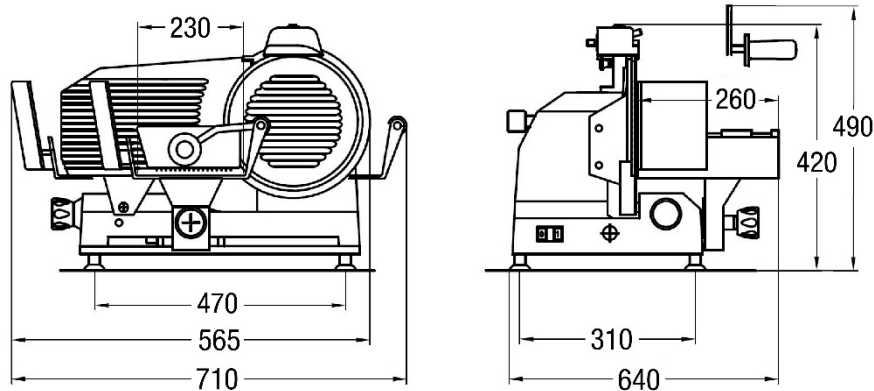

Specifications

Model	Blade (mm) / (Inch)	Phase (Ø)	Motor (Volt)	Frequency (Hz)	Current (Amp)	Power (kW)
NSV300	300 / 12	1	220	50	0.82	0.180

Capacity

Model	Cutting Capacity (mm)		Carriage Movement (mm)	Max Slice Thickness (mm)
NSV300	● 205	□ 205 x 230	275	13

Dimensions | Shipping Information

Model	Overall Dimensions D x W x H (mm)	Net Weight (kg)	Packed Dimensions D x W x H (mm)	Packed Weight (kg)	Volume (m3)
NSV300	640 x 710 x 490	23	560 x 660 x 620	26	0.229

We reserve the right to alter the specification and technical details for this item at any time without prior notice.

3/2021

Metcalfe Catering Equipment Ltd

Haygarth Park

Blaenau Ffestiniog

Gwynedd, LL41 3PF

